

Equipamiento para cocina y baño / Pies de cocina / Pies Bone / Pies Bone 60-80

Ficha técnica de producto



## Pies Bone 60-80

Pies Bone

CATAS®

Especificaciones

Altura Zócalo	H		Cod.	Acabado
60	59 - 75	100	<b>3911317</b>	Plástico negro
80	79 - 95	100	<b>3911417</b>	Plástico negro

Croquis

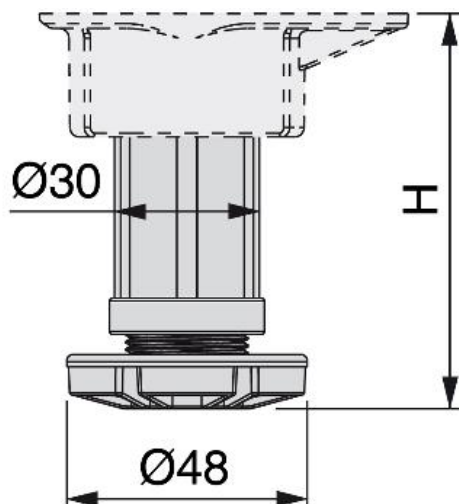

## Información

Sistema de pies para módulos bajos de cocina.

Compatible con los zócalos de aluminio y con los de madera mediante montaje tornillo con recalada.

Embalaje en bolsas de 4 unidades en cajas de 100pies.

Usar tornillos de Ø3,5mm para la base escuadra y de Ø4 o Ø4,5mm para el resto.

## Productos imprescindibles



### Base montaje mediante tornillo



	Cod.	Acabado
100	<b>3912117</b>	Plástico negro

### Base montaje directo



	Ø		Cod.	Acabado
12	12.5	100	<b>3912217</b>	Plástico negro
13	13.5	100	<b>3913217</b>	Plástico negro
15	15.5	100	<b>3913117</b>	Plástico negro
16	16.5	100	<b>3912417</b>	Plástico negro

### Base escuadra montaje directo Ø10



	Cod.	Acabado
100	<b>3912517</b>	Plástico negro

### Pinza montaje directo/tornillo



	Cod.	Acabado
200	<b>3912917</b>	Plástico negro

### Pinza para zócalos Line 2 y Plasline 2



	Cod.	Acabado
200	<b>3913017</b>	Plástico negro

Tornillo M10



	Cod.	Acabado
200	<b>3912605</b>	Cincado

Tapas



	Cod.	Acabado
200	<b>3912715</b>	Plástico blanco