

Ficha técnica de producto



Base montaje mediante tornillo

Pies Bone



Especificaciones

	Cod.	Acabado
100	3912117	Plástico negro

Croquis

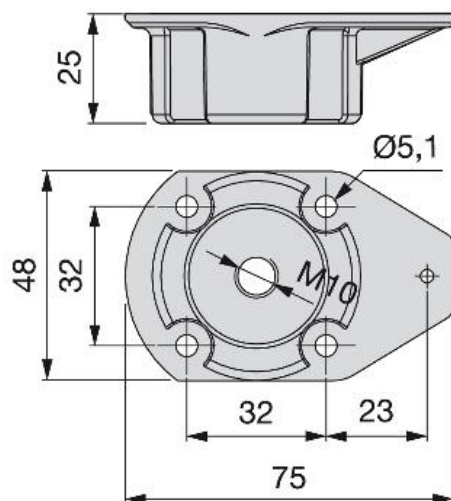

Información

Sistema de pies para módulos bajos de cocina.

Compatible con los zócalos de aluminio y con los de madera mediante montaje tornillo con recalada.

Embalaje en bolsas de 4 unidades en cajas de 100pies.

Usar tornillos de Ø3,5mm para la base escuadra y de Ø4 o Ø4,5mm para el resto.

Productos imprescindibles

Pies Bone 60-80



Altura Zócalo	H		Cod.	Acabado
60	59 - 75	100	3911317	Plástico negro
80	79 - 95	100	3911417	Plástico negro



Pies Bone 100-150



Altura Zócalo	H		Cod.	Acabado
100 - 120	98 - 140	100	3911817	Plástico negro
120 - 150	118 - 160	100	3911917	Plástico negro
150 - 165 - 180	148 - 190	100	3912017	Plástico negro

Base montaje directo



	Ø		Cod.	Acabado
12	12.5	100	3912217	Plástico negro
13	13.5	100	3913217	Plástico negro
15	15.5	100	3913117	Plástico negro
16	16.5	100	3912417	Plástico negro

Base escuadra montaje directo Ø10



	Cod.	Acabado
100	3912517	Plástico negro

Pinza montaje directo/tornillo



	Cod.	Acabado
200	3912917	Plástico negro

Pinza para zócalos Line 2 y Plasline 2



	Cod.	Acabado
200	3913017	Plástico negro

Tornillo M10



	Cod.	Acabado
200	3912605	Cincado

Tapas



	Cod.	Acabado
200	3912715	Plástico blanco