

Equipamiento para cocina y baño / Pies de cocina / Pies Bone / Pinza montaje directo/tornillo

Ficha técnica de producto



Pinza montaje directo/tornillo

Pies Bone

Especificaciones

	Cod.	Acabado
200	3912917	Plástico negro

Croquis

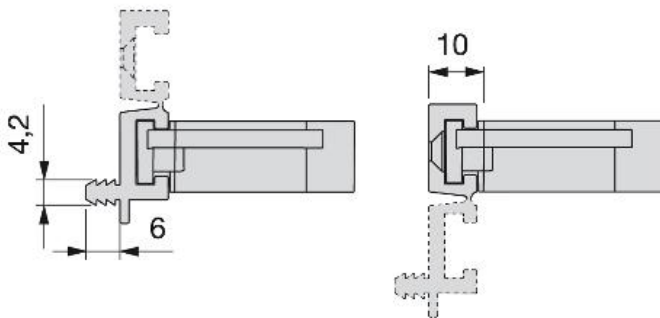

Información

Sistema de pies para módulos bajos de cocina.

Compatible con los zócalos de aluminio y con los de madera mediante montaje tornillo con recalada.

Embalaje en bolsas de 4 unidades en cajas de 100pies.

Usar tornillos de Ø3,5mm para la base escuadra y de Ø4 o Ø4,5mm para el resto.

Montaje

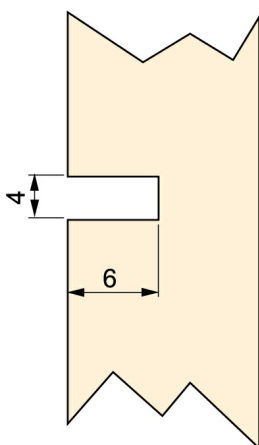

Productos imprescindibles

Pies Bone 60-80



Altura Zócalo	H		Cod.	Acabado
60	59 - 75	100	3911317	Plástico negro
80	79 - 95	100	3911417	Plástico negro

Pies Bone 100-150



Altura Zócalo	H		Cod.	Acabado
100 - 120	98 - 140	100	3911817	Plástico negro
120 - 150	118 - 160	100	3911917	Plástico negro
150 - 165 - 180	148 - 190	100	3912017	Plástico negro

Base montaje mediante tornillo



	Cod.	Acabado
100	3912117	Plástico negro



Base escuadra montaje directo Ø10



	Cod.	Acabado
100	3912517	Plástico negro

Base montaje directo



	Ø		Cod.	Acabado
12	12.5	100	3912217	Plástico negro
13	13.5	100	3913217	Plástico negro
15	15.5	100	3913117	Plástico negro
16	16.5	100	3912417	Plástico negro

Pinza para zócalos Line 2 y Plasline 2



	Cod.	Acabado
200	3913017	Plástico negro

Tornillo M10



	Cod.	Acabado
200	3912605	Cincado

Tapas



	Cod.	Acabado
200	3912715	Plástico blanco